













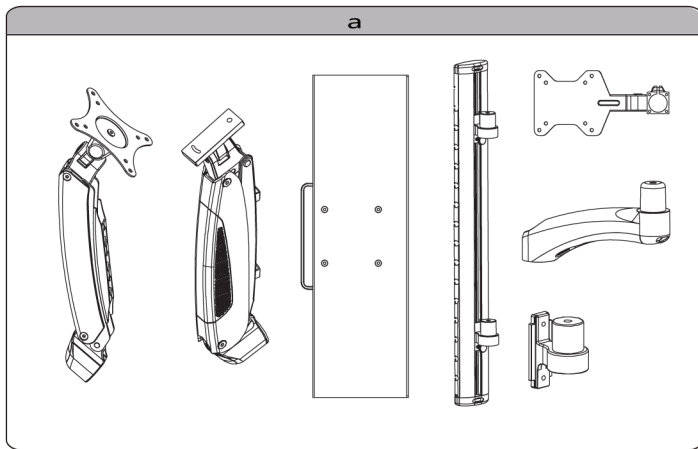





Plasma/LCD TV Stand Assembly Instruction

Max. VESA 75x75/100x100





 max.
3-8kg(6.6-18lbs)

13" - 27"(33-69cm)



B	 M 4x12 (x4)	 M 6x15 (x2)		
C	 M 5x18 (x1)	 M 5x10 (x4)	 M 5 (x4)	 Ø14x6.5x1 (x1)
D	 M 6x25 (x3)	 (x3)		
E	 S=3m (x1)	 S=4m (x1)	 S=5m (x1)	 (x5)
F	 Ø8x40 (x3)	 M 6x50 (x3)		

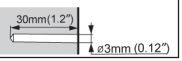

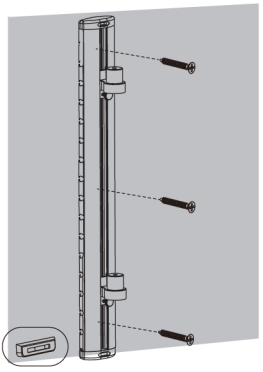

INSTALLATION

①      F

wood, wood stud wall

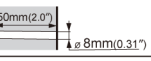

OR

②      F

concrete wall

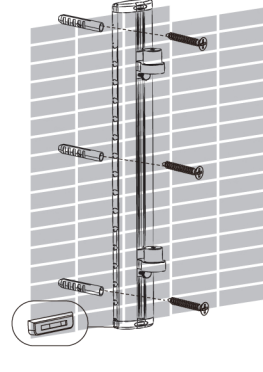

 C
 E

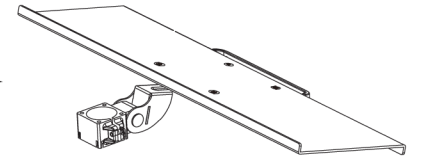
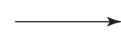
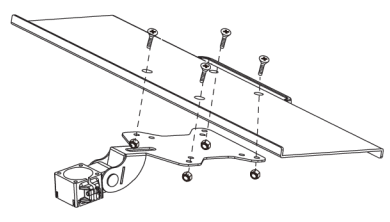
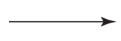
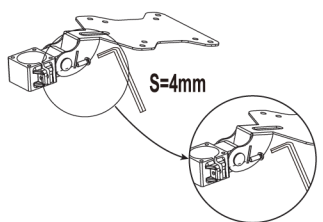

 C
 C

